

2 ENLARGED STREETSCAPE SECTION_3RD ST
A.56 1/8" = 1'-0"

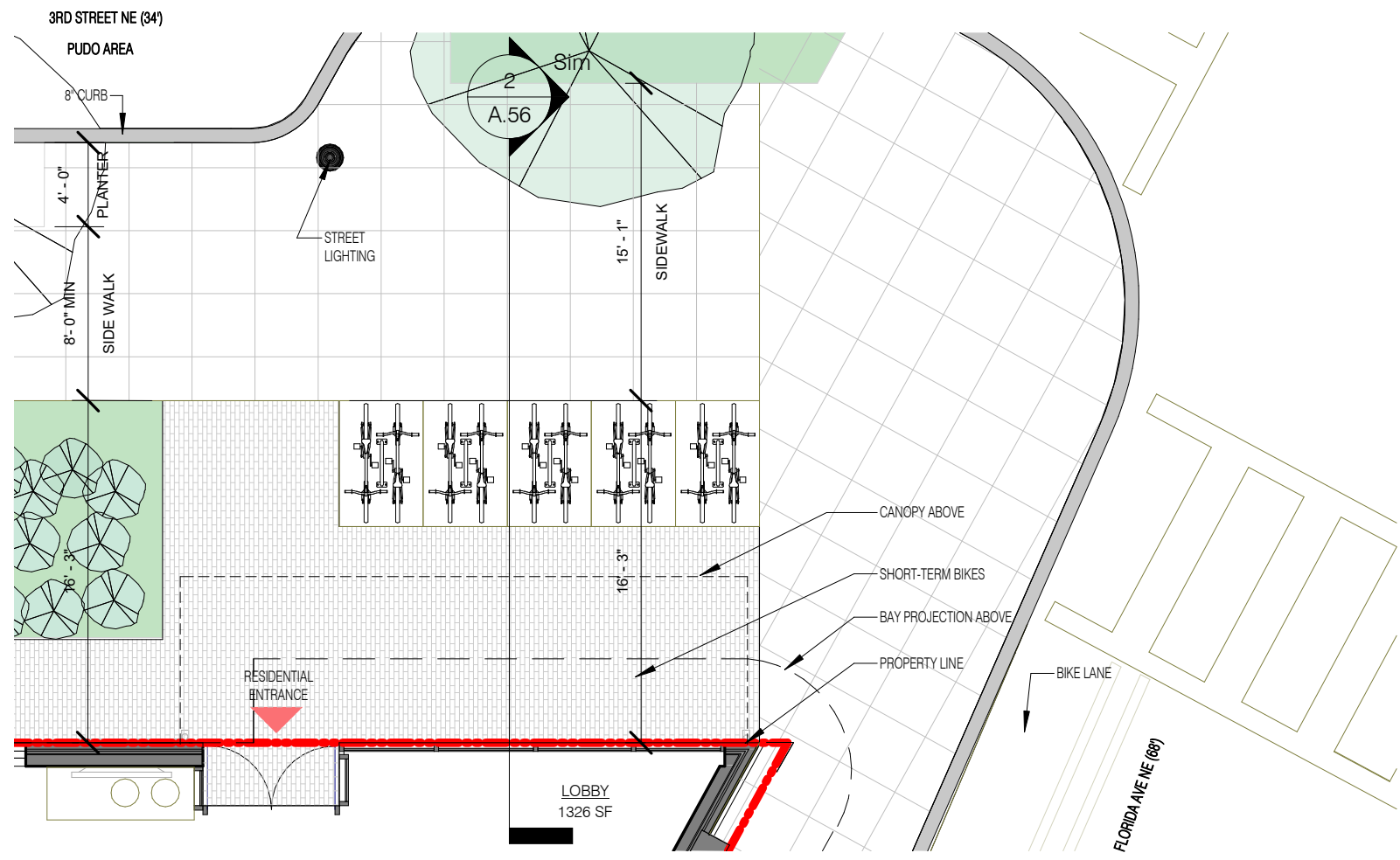

1 ENLARGED STREETSCAPE_3RD ST NE
A.56 1/8" = 1'-0"

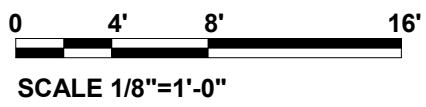

NoMA/Union Market Affordable

301 Florida Ave NE, Washington, DC 20002

COPYRIGHT © 2020 PGN ARCHITECTS, PLLC



STREETSCAPE SECTION 3RD ST NE A.56

07/07/2022

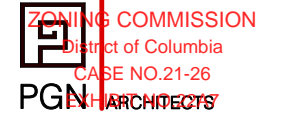

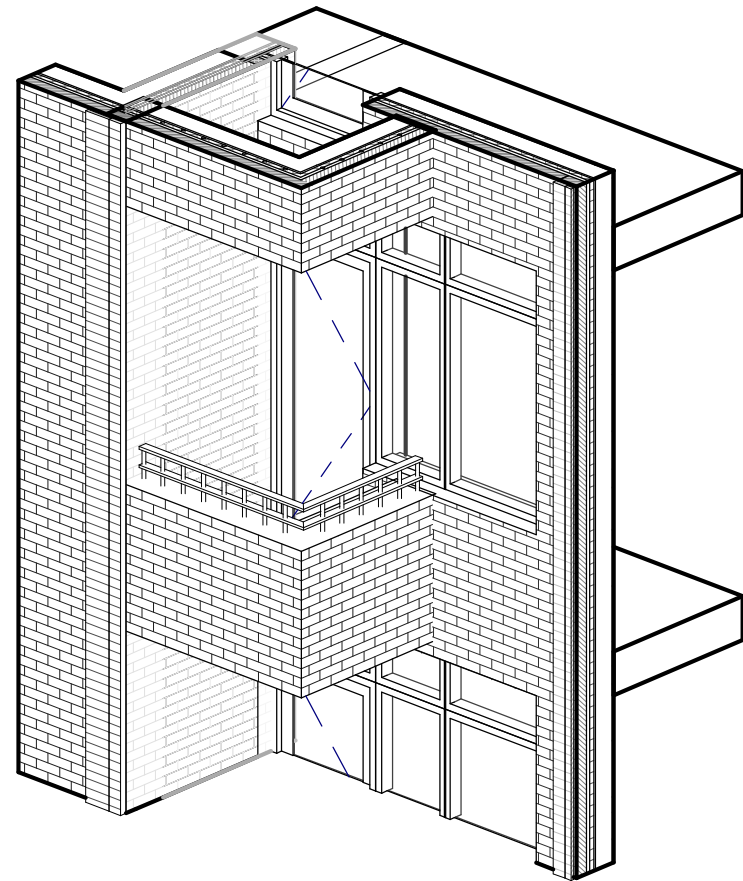

1 Typical Projected Balcony_ 3D View

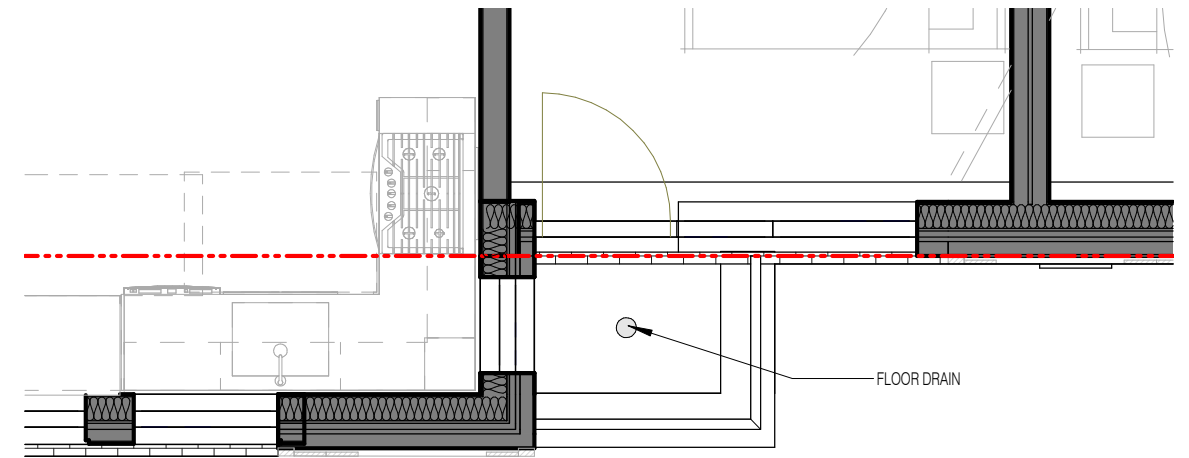

2 Typical Projected Balcony_ PLAN DETAIL
1/4" = 1'-0"

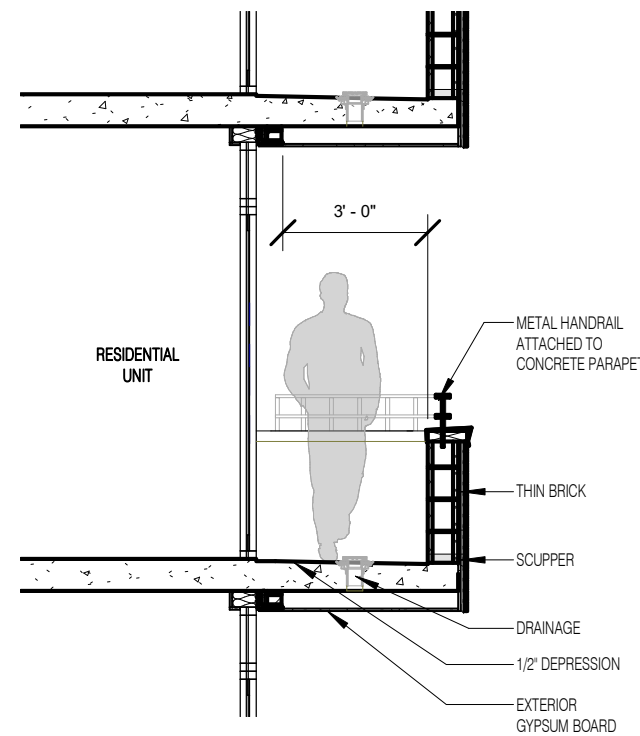

4 Typical Projected Balcony_ SECTION DETAIL
1/4" = 1'-0"

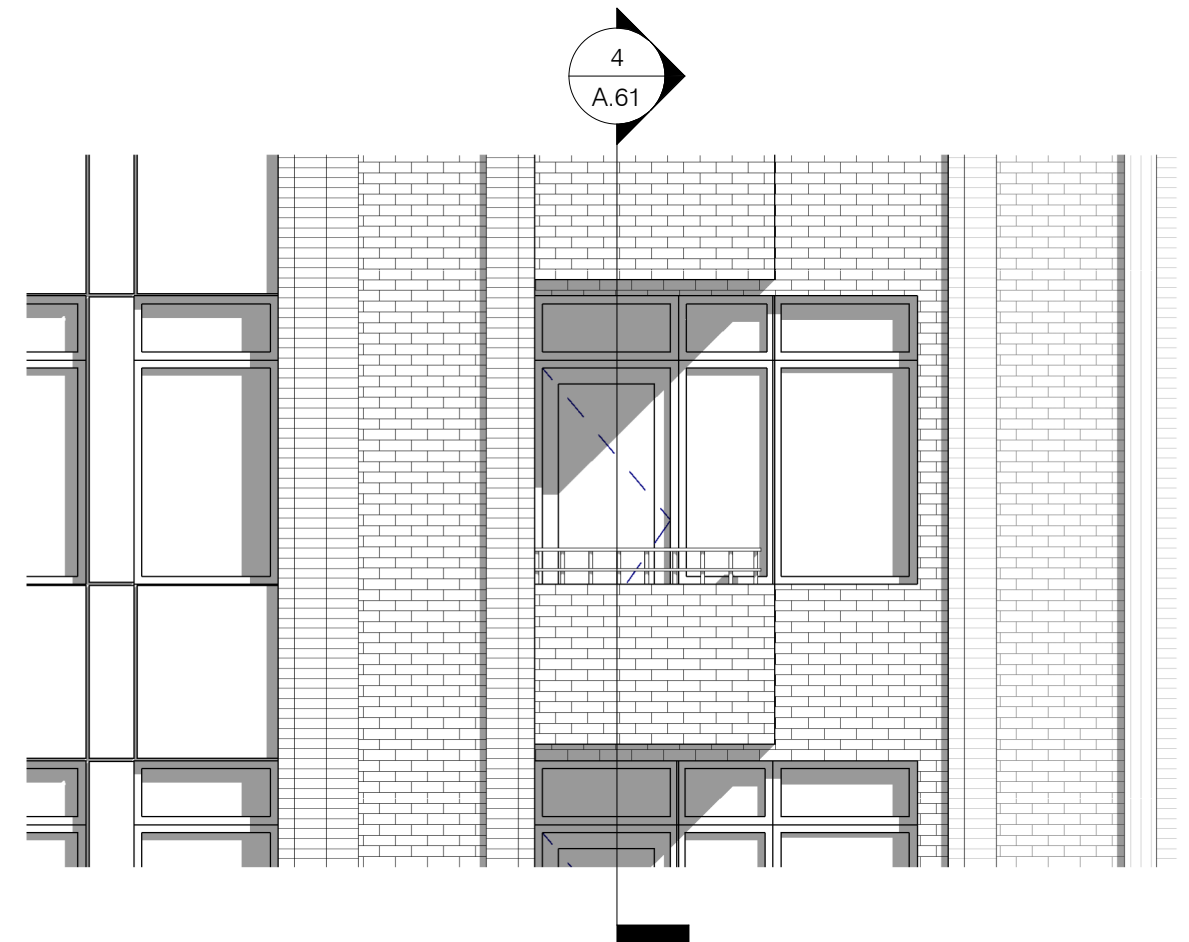

3 Typical Projected Balcony_ ELEVATION
1/4" = 1'-0"

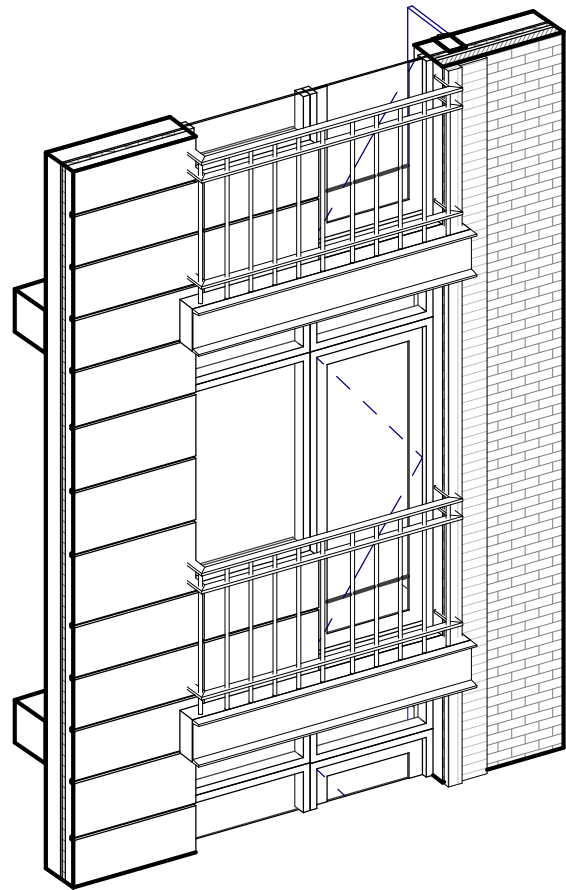

1 TYP. JULIET BALCONY 3D View 1

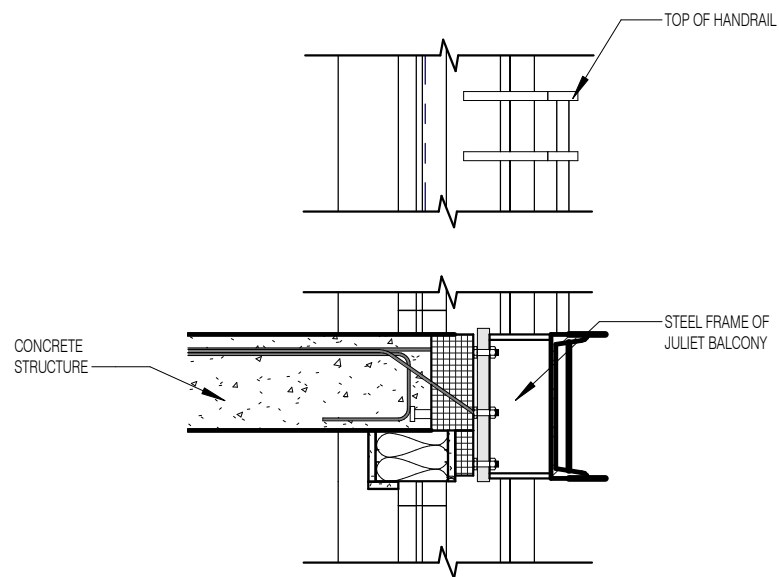

5 TYP. JULIET BALCONY DETAIL
3/4" = 1'-0"

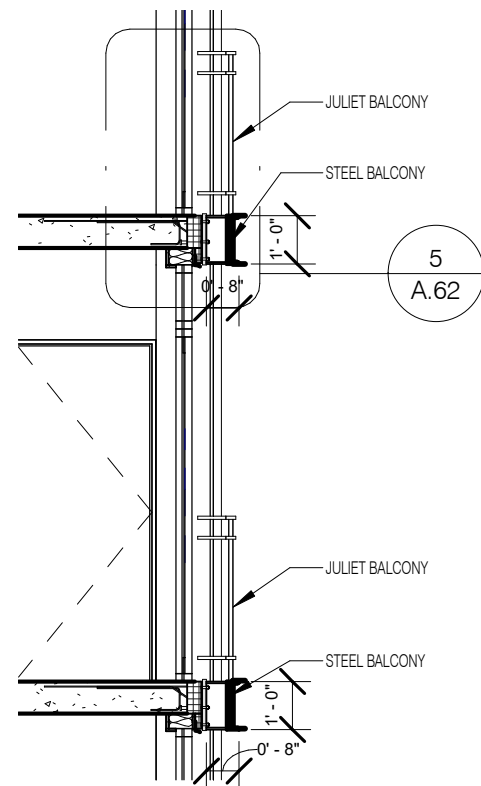

4 TYP. JULIET BALCONY SECTION
1/4" = 1'-0"

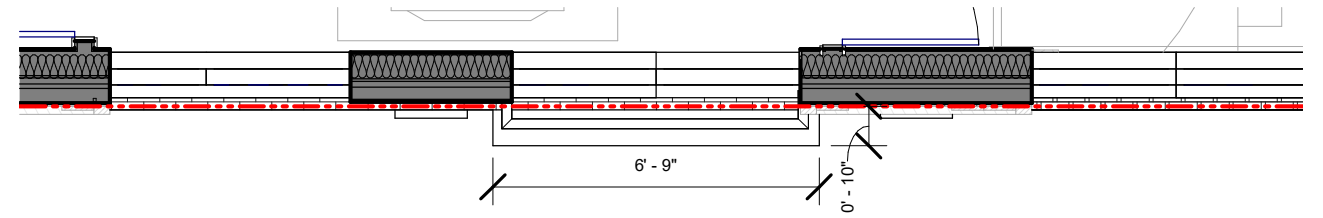

2 TYP. JULIET BALCONY PLAN DETAIL
1/4" = 1'-0"

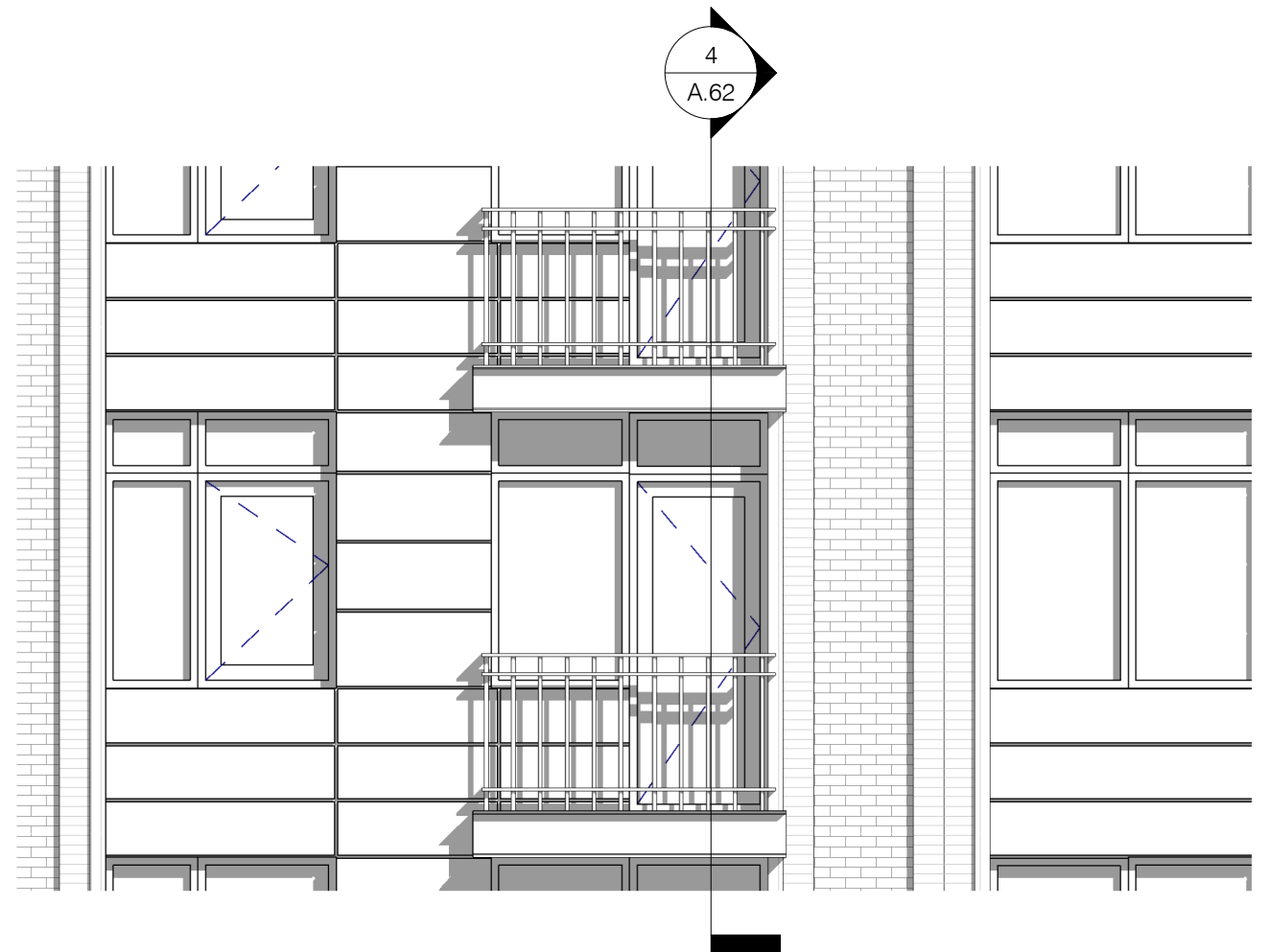

3 TYP. JULIET BALCONY ELEVATION
1/4" = 1'-0"

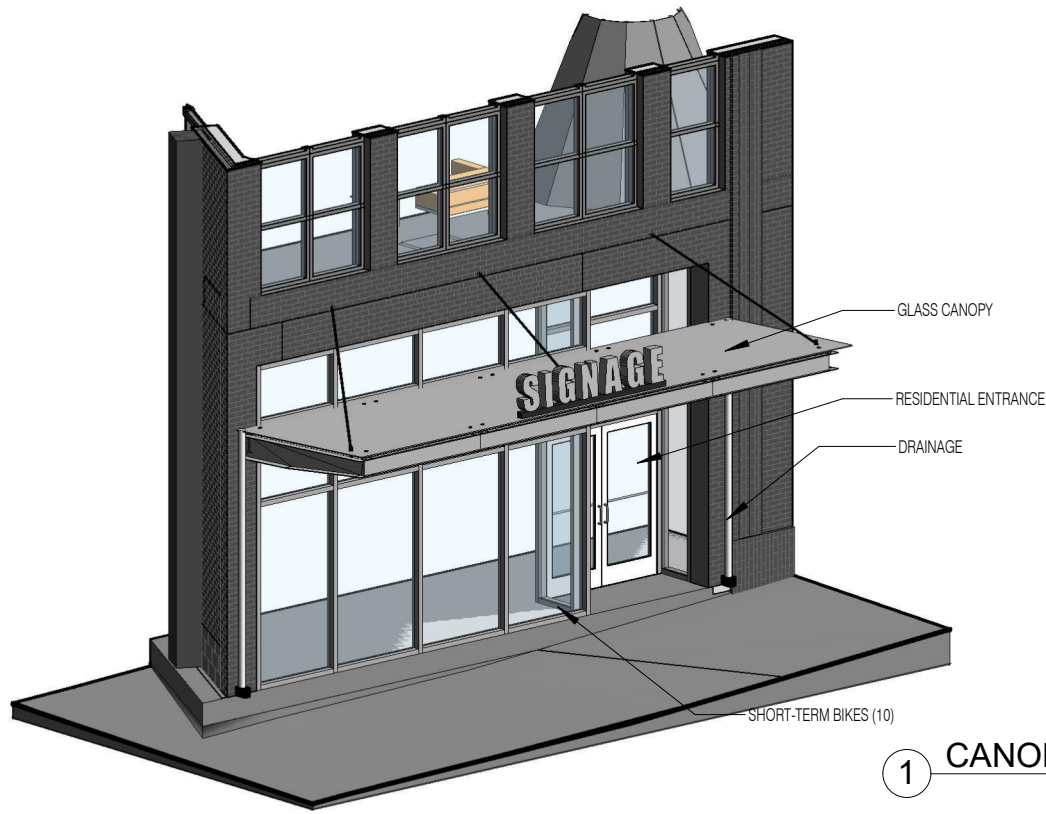

1 CANOPY 1 3D View 1

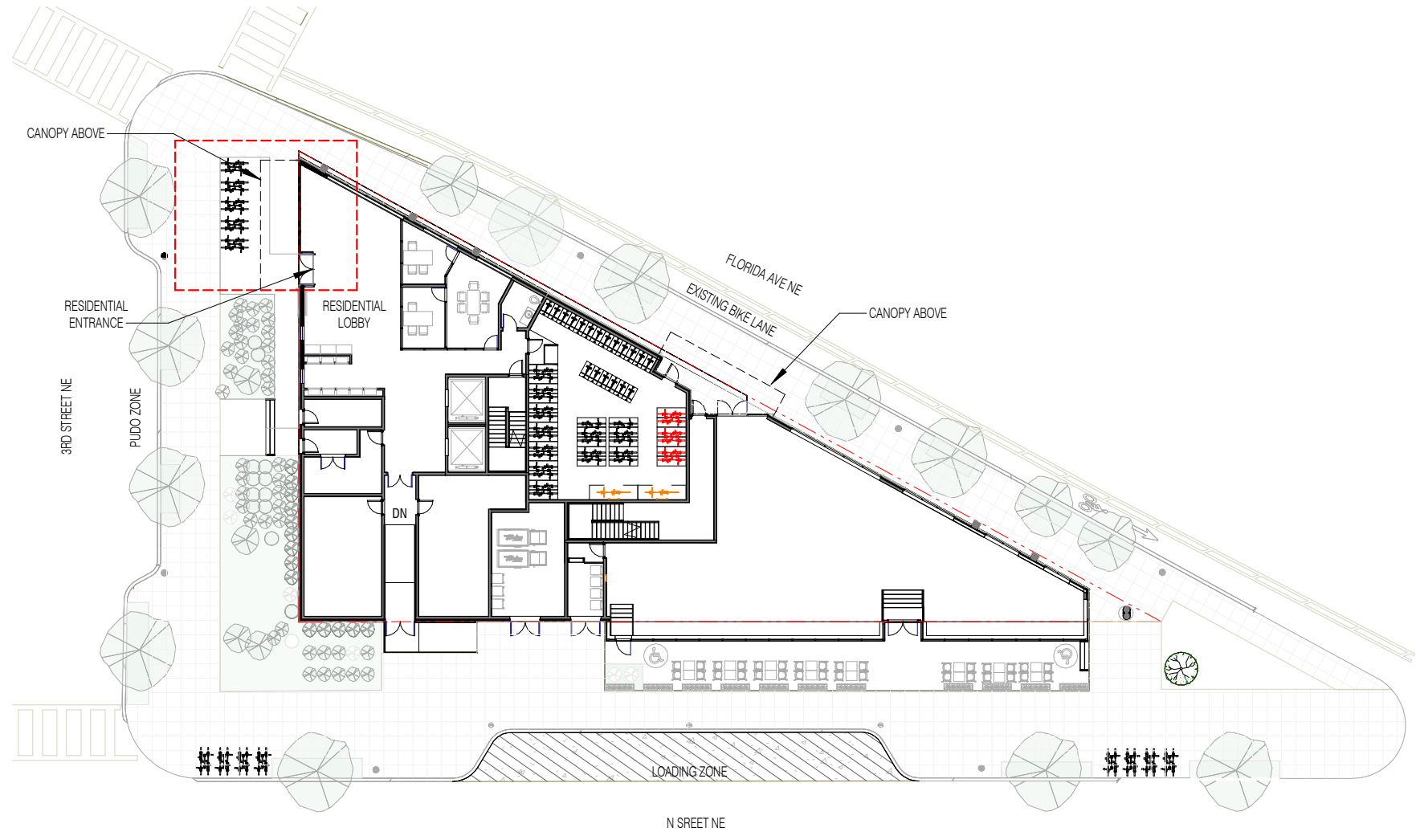

2 CANOPY 1 PLAN LOCATION
1/32" = 1'-0"

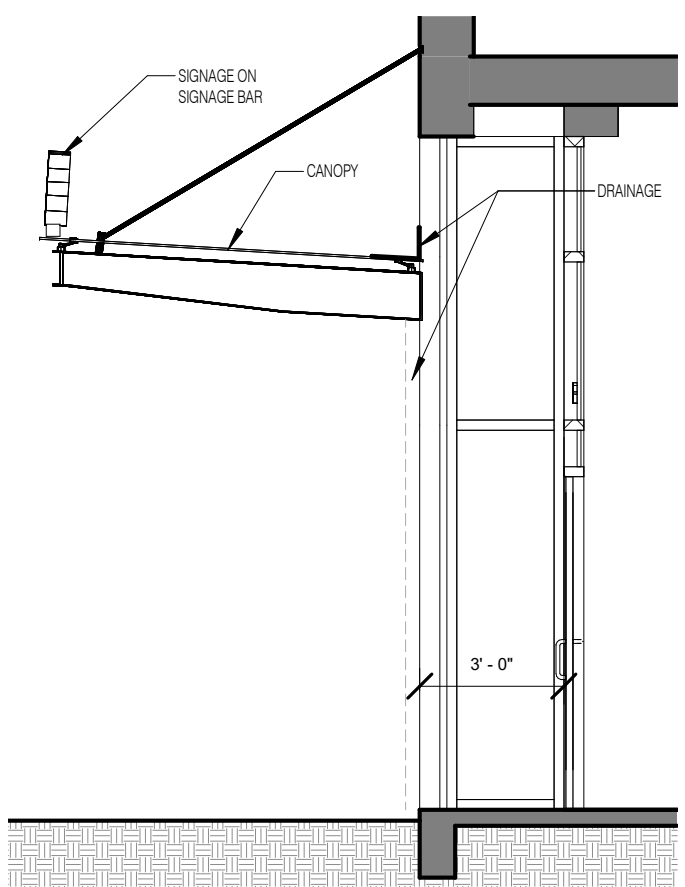

4 CANOPY 1 SECTION
1/4" = 1'-0"

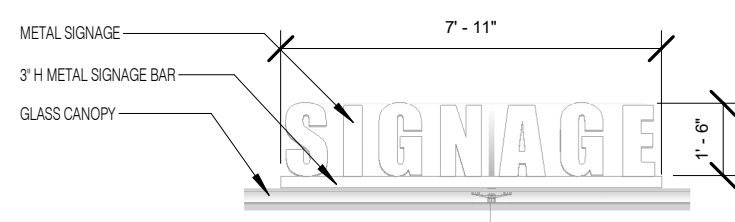

5 SIGNAGE DETAIL 2
1/4" = 1'-0"

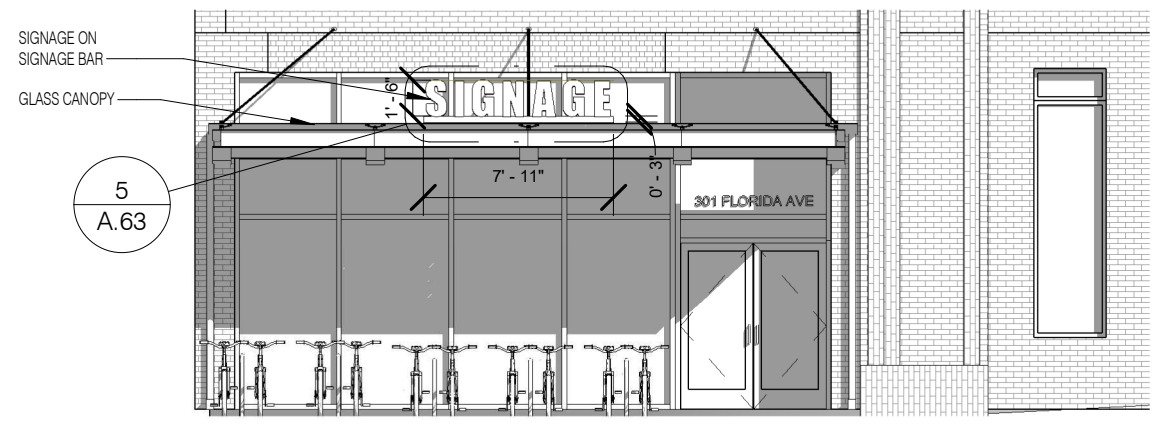

3 CANOPY 1 ELEVATION
1/8" = 1'-0"

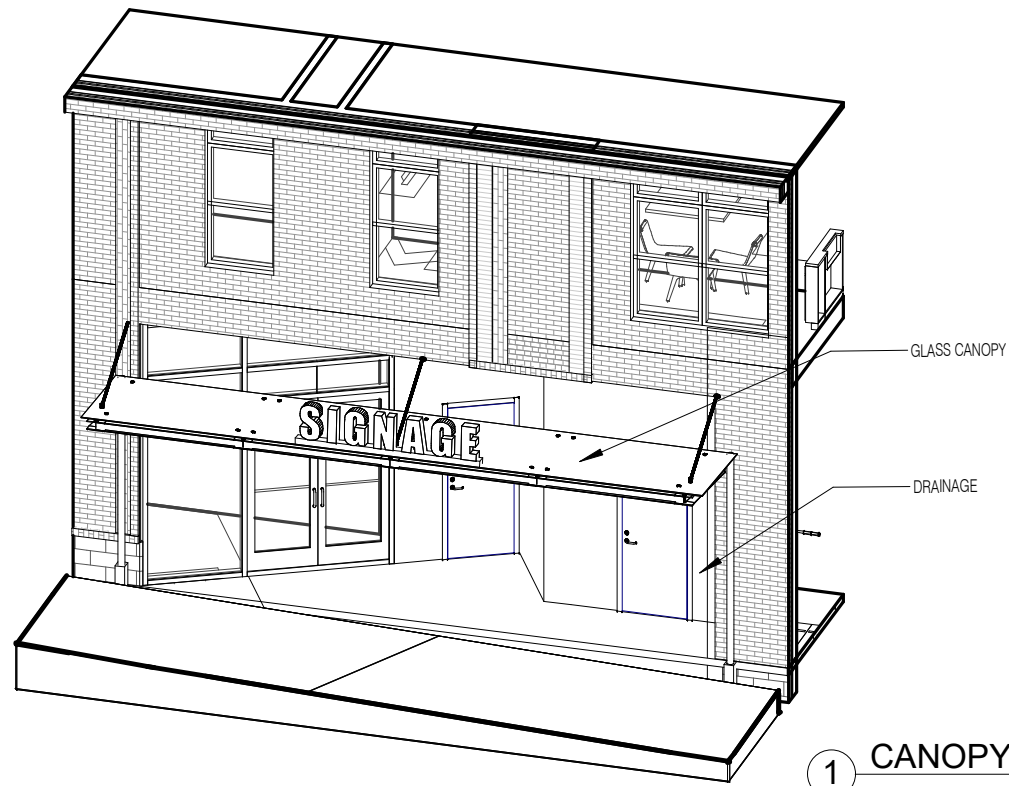

1 CANOPY 2 3D View 1

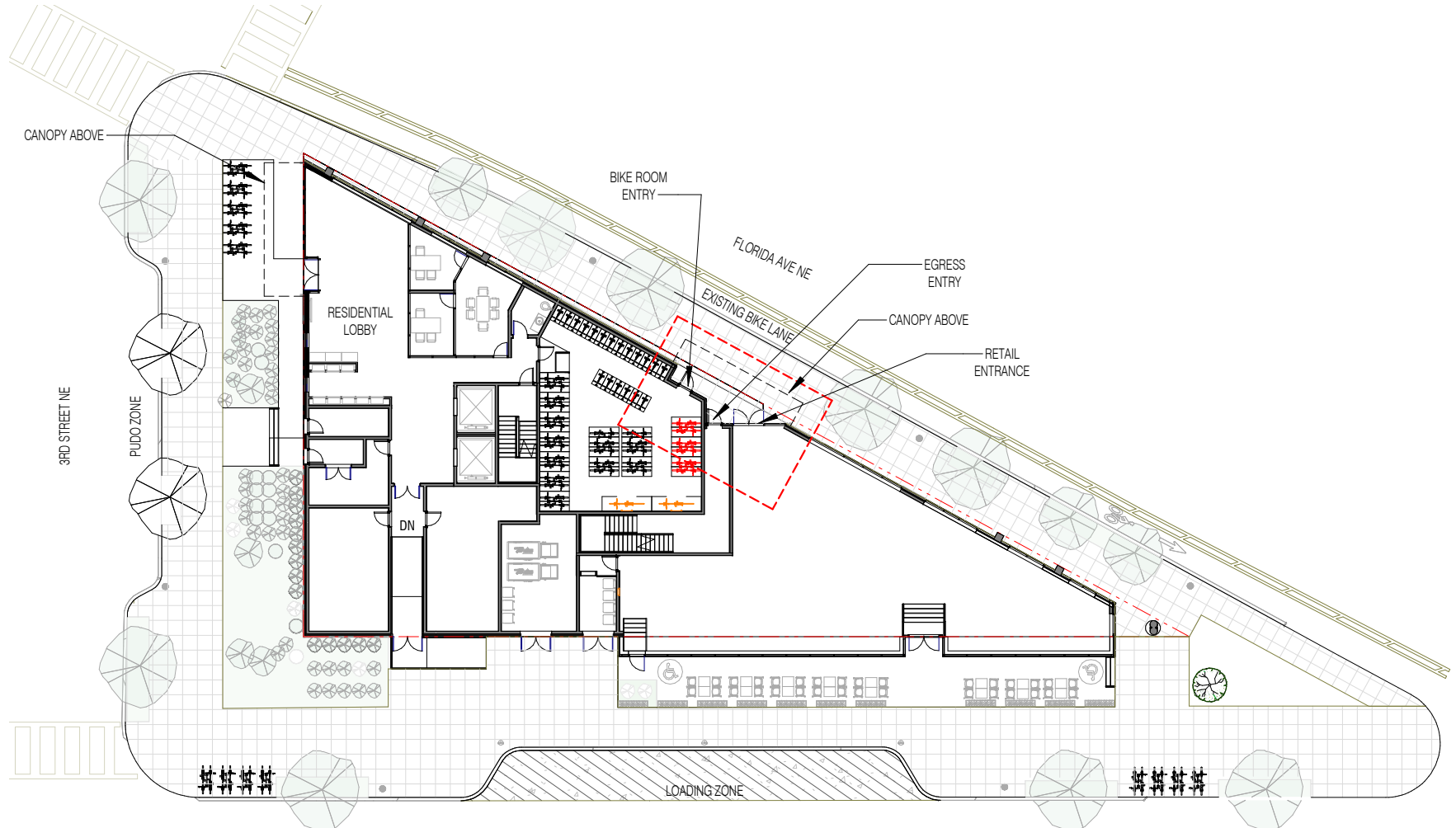

2 CANOPY 2 PLAN LOCATION
1/32" = 1'-0"

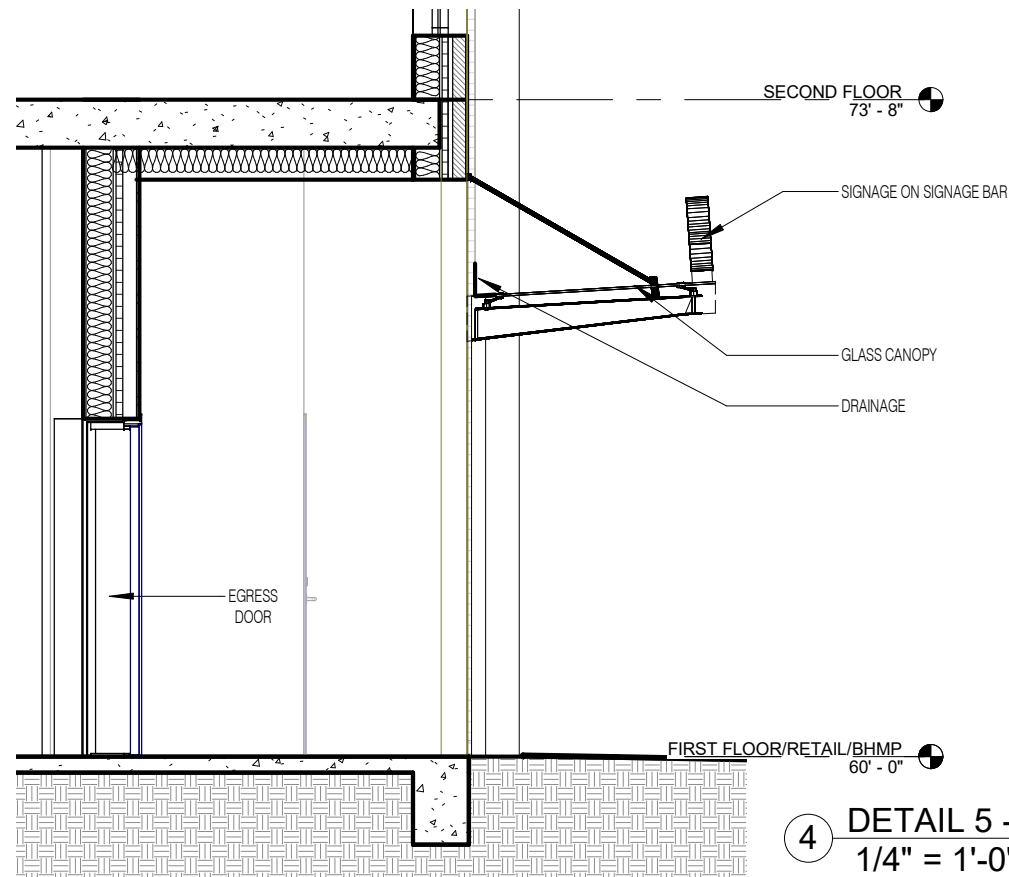

4 DETAIL 5 - SECTION
1/4" = 1'-0"

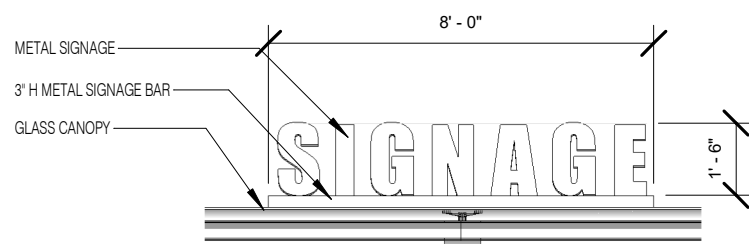

6 SIGNAGE DETAIL.
1/4" = 1'-0"

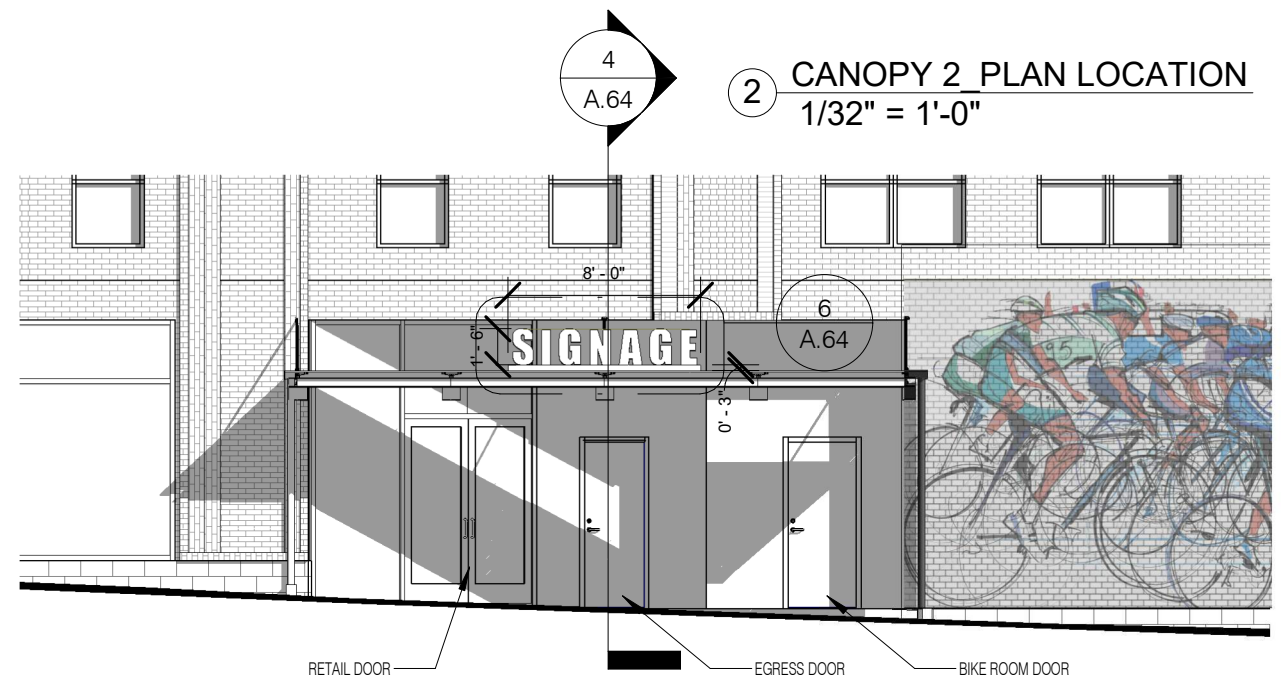

3 DETAIL 5 - ELEVATION
1/8" = 1'-0"



NoMA/Union Market Affordable

301 Florida Ave NE, Washington, DC 20002

RENDERING OF FLORIDA AVE FACADE | A.70

COPYRIGHT © 2020 PGN ARCHITECTS, PLLC



07/07/2022





* RENDERINGS ARE ILLUSTRATED PURPOSE ONLY AND SUBJECT TO CHANGE.

NoMA/Union Market Affordable

301 Florida Ave NE, Washington, DC 20002

RENDERING OF 3RD & N ST FACADE | A.71

COPYRIGHT © 2020 PGN ARCHITECTS, PLLC



07/07/2022





* RENDERINGS ARE ILLUSTRATED PURPOSE ONLY AND SUBJECT TO CHANGE.

NoMA/Union Market Affordable

301 Florida Ave NE, Washington, DC 20002

RENDERING OF FLORIDA AVE FACADE | A.72

COPYRIGHT © 2020 PGN ARCHITECTS, PLLC



07/07/2022

